

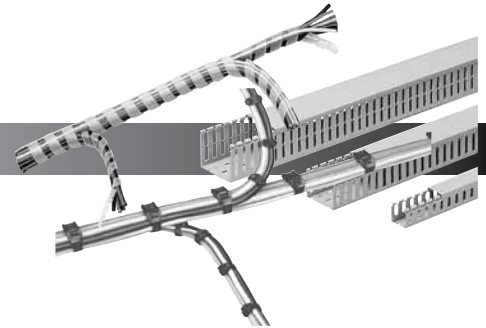

14 - Wire duct, wire ties & spiral wrap



General information 14.1

Q-Duct..... 14.1 - 14.14

 Catalog number explanation..... 14.1

 Standard, 8-12mm slot..... 14.2

 High density, 4-6mm slot..... 14.3

 Tools and accessories..... 14.4

 Wire duct cutters..... 14.5

 Resistance to chemical agents..... 14.6

 Wire capacity, 18-750 AWG..... 14.7

 Wire capacity, 800 - 1000 AWG..... 14.8

 Approximate dimensions..... 14.9 - 14.11

 Catalog number cross-reference..... 14.12 - 14.13

Q-Flex 14.15 - 14.16

Q-Wrap..... 14.17 - 14.18

Q-Ties..... 14.19 - 14.24

 Features and applications..... 14.19

 Cable ties..... 14.20

 Accessories..... 14.21

 Technical data & approximate dimensions..... 14.22 - 14.24

Wire duct, wire ties
& spiral wrap

Notes

Q-Duct wiring duct



Q-Duct Wiring duct

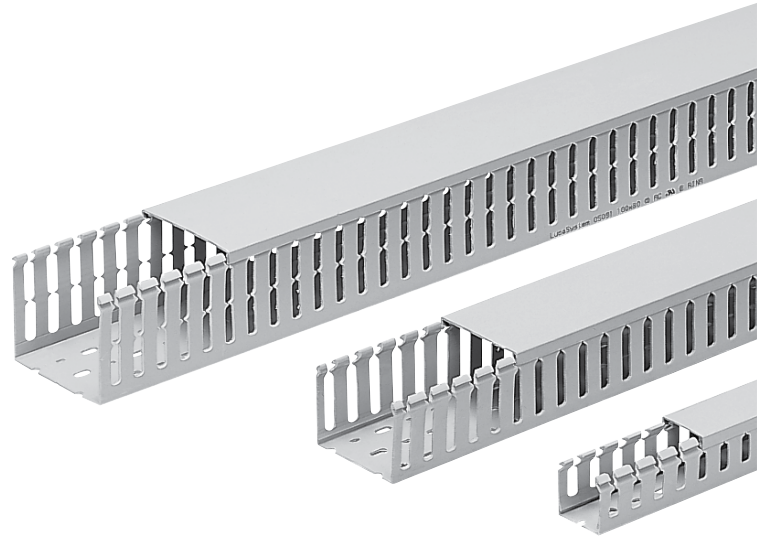

General information

ABB offers Q-Duct, a wide variety of wire duct and accessories. Wire duct bases are available in six nominal widths - 1/2" to 6" - and six nominal heights - 5/8" to 4". The top profile of the wire duct makes the covers easier to install and remove. The rounded shape of the ribs prevents abrasions to both the installer's hands and wires. The score line at the base of each rib enables a clean break to create openings for running wires. ABB wire duct is used in applications with rated voltages up to 1000 VAC and 1500 VDC.

UL 94

UL file number: E125800

14

Catalog number explanation

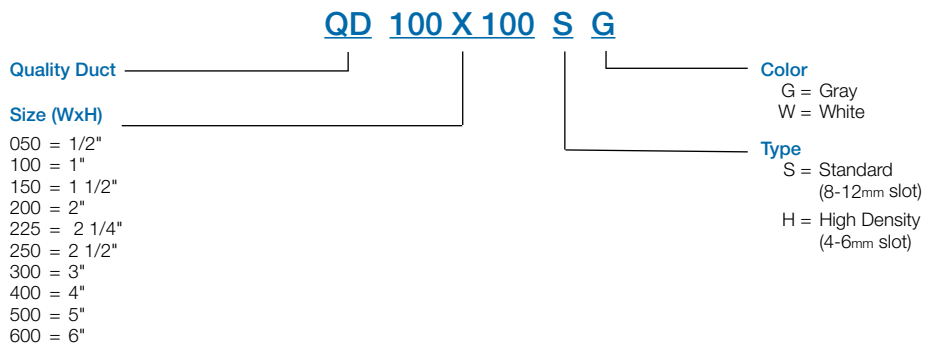

Wire duct, ties,
spiral wrap

Q-Duct Standard, 8-12mm slot^①

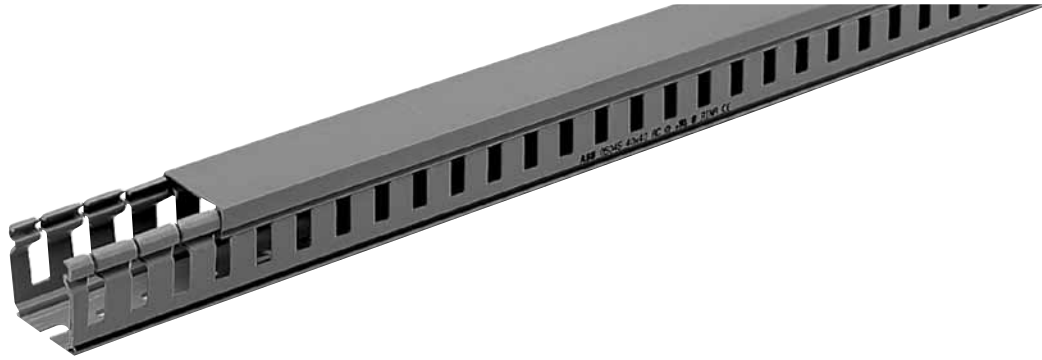

Dimensions WXH (in)	White Standard 8-12mm slot Catalog number	Gray Standard 8-12mm slot Catalog number	Dimensions WXH (mm)	Feet per package	Meters per package	Pieces per package
1/2 X 5/8	QD050X050SW	QD050X050SG	15 x 17	151	46	23
1 X 1 1/4	QD100X125SW	QD100X125SG	25 x 30	190.5	58	29
1 1/2 X 1 1/4	QD150X125SW	QD150X125SG	40 x 30	131.5	40	20
2 1/4 X 1 1/4	QD225X125SW	QD225X125SG	60 x 30	171	52	26
1 x 1 1/2	QD100X150SW	QD100X150SG	25 x 40	157.5	48	24
1 1/2 x 1 1/2	QD150X150SW	QD150X150SG	40 x 40	98.5	30	15
2 1/4 x 1 1/2	QD225X150SW	QD225X150SG	60 x 40	131	40	20
3 x 1 1/2	QD300X150SW	QD300X150SG	80 x 40	105	32	16
4 x 1 1/2	QD400X150SW	QD400X150SG	100 x 40	79	24	12
4 3/4 x 1 1/2	QD475X150SW	QD475X150SG	120 x 40	66	20	10
1 x 2 1/4	QD100X225SW	QD100X225SG	25 x 60	111.5	34	17
1 1/2 x 2 1/4	QD150X225SW	QD150X225SG	40 x 60	72	22	11
2 1/4 x 2 1/4	QD225X225SW	QD225X225SG	60 x 60	105	32	16
3 x 2 1/4	QD300X225SW	QD300X225SG	80 x 60	79	24	12
4 x 2 1/4	QD400X225SW	QD400X225SG	100 x 60	66	20	10
4 3/4 x 2 1/4	QD475X225SW	QD475X225SG	120 x 60	46	14	7
1 x 3	QD100X300SW	QD100X300SG	25 x 80	92	28	14
1 1/2 x 3	QD150X300SW	QD150X300SG	40 x 80	118	36	18
2 1/4 x 3	QD225X300SW	QD225X300SG	60 x 80	79	24	12
3 x 3	QD300X300SW	QD300X300SG	80 x 80	52	16	8
4 x 3	QD400X300SW	QD400X300SG	100 x 80	52	16	8
4 3/4 x 3	QD475X300SW	QD475X300SG	120 x 80	39	12	6
1 x 4	QD100X400SW	QD100X400SG	25 x 100	65.5	20	10
1 1/2 x 4	QD150X400SW	QD150X400SG	40 x 100	92	28	14
2 1/4 x 4	QD225X400SW	QD225X400SG	60 x 100	66	20	10
3 x 4	QD300X400SW	QD300X400SG	80 x 100	46	14	7
4 x 4	QD400X400SW	QD400X400SG	100 x 100	26	8	4
6 x 4	QD600X400SW	QD600X400SG	150 x 100	26	8	4

Sold in package quantity only. Order quantity must be equal to quantity shown in "Pieces per package" column. Wire duct cover included.

^① Wire duct cover included in price.

Q-Duct

High density, 4-6mm slot ^①

Wire duct, ties,
spiral wrap

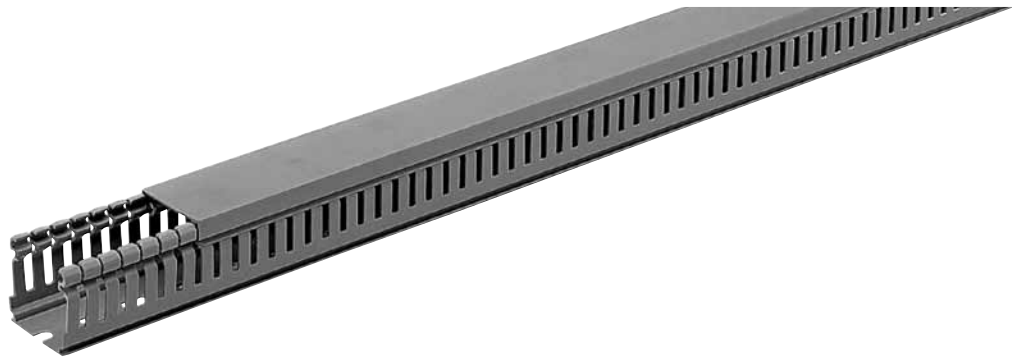

Dimensions WXH (in)	White High Density, 4-6mm slot Catalog number	Gray High Density, 4-6mm slot Catalog number	Dimensions WXH (mm)	Feet per package	Meters per package	Pieces per package
1/2 x 5/8	QD050X050HW	QD050X050HG	15 x 17	151	46	23
1 x 1 1/4	QD100X125HW	QD100X125HG	25 x 30	190.5	58	29
1 1/2 x 1 1/4	QD150X125HW	QD150X125HG	40 x 30	131.5	40	20
2 1/4 x 1 1/4	QD225X125HW	QD225X125HG	60 x 30	171	52	26
1 x 1 1/2	QD100X150HW	QD100X150HG	25 x 40	157.5	48	24
1 1/2 x 1 1/2	QD150X150HW	QD150X150HG	40 x 40	98.5	30	15
2 1/4 x 1 1/2	QD225X150HW	QD225X150HG	60 x 40	131	40	20
3 x 1 1/2	QD300X150HW	QD300X150HG	80 x 40	105	32	16
4 x 1 1/2	QD400X150HW	QD400X150HG	100 x 40	79	24	12
4 3/4 x 1 1/2	QD475X150HW	QD475X150HG	120 x 40	66	20	10
1 x 2 1/4	QD100X225HW	QD100X225HG	25 x 60	111.5	34	17
1 1/2 x 2 1/4	QD150X225HW	QD150X225HG	40 x 60	72	22	11
2 1/4 x 2 1/4	QD225X225HW	QD225X225HG	60 x 60	105	32	16
3 x 2 1/4	QD300X225HW	QD300X225HG	80 x 60	79	24	12
4 x 2 1/4	QD400X225HW	QD400X225HG	100 x 60	66	20	10
4 3/4 x 2 1/4	QD475X225HW	QD475X225HG	120 x 60	46	14	7
1 x 3	QD100X300HW	QD100X300HG	25 x 80	92	28	14
1 1/2 x 3	QD150X300HW	QD150X300HG	40 x 80	118	36	18
2 1/4 x 3	QD225X300HW	QD225X300HG	60 x 80	79	24	12
3 x 3	QD300X300HW	QD300X300HG	80 x 80	52	16	8
4 x 3	QD400X300HW	QD400X300HG	100 x 80	52	16	8
4 3/4 x 3	QD475X300HW	QD475X300HG	120 x 80	39	12	6
1 x 4	QD100X400HW	QD100X400HG	25 x 100	65.5	20	10
1 1/2 x 4	QD150X400HW	QD150X400HG	40 x 100	92	28	14
2 1/4 x 4	QD225X400HW	QD225X400HG	60 x 100	66	20	10
3 x 4	QD300X400HW	QD300X400HG	80 x 100	46	14	7
4 x 4	QD400X400HW	QD400X400HG	100 x 100	26	8	4
6 x 4	QD600X400HW	QD600X400HG	150 x 100	26	8	4

14

Sold in package quantity only. Order quantity must be equal to quantity shown in "Pieces per package" column. Wire duct cover included.

① Wire duct cover included in price.

Q-Duct Tools and accessories

Spare wire duct covers



QDC050G

Dimensions width (in.)	Dimensions width (mm)	Grey Catalog number	White Catalog number	Feet per package	Meters per package	Pieces per package
1/2"	15	QDC050G	QDC050W	656	200	100
1"	25	QDC100G	QDC100W	197	60	30
1 1/2"	40	QDC150G	QDC150W	131	40	20
2 1/4"	60	QDC225G	QDC225W	79	24	12
3"	80	QDC300G	QDC300W	52	16	8
4"	100	QDC400G	QDC400W	157	48	24
4 3/4"	120	QDC475G	QDC475W	118	36	18
6"	150	QDC600G	QDC600W	92	28	14



Rapid DIN rail clips

Rapid clip for DIN rail

Item	Catalog number	Pieces per package
25mm base	QDRCD100B	20
40mm base	QDRCD150B	
60mm base	QDRCD225B	
80mm base	QDRCD300B	
100mm base	QDRCD400B	
120mm base	QDRCD500B	
150mm base	QDRCD600B	



QDWS8-12-150B

Wire stops

Item	Catalog number	Pieces per package
40mm base	QDWS8-12-150B	100
60mm base	QDWS8-12-225B	
80mm base	QDWS8-12-300	
100/120mm base	QDWS8-12-400	



QDCUTR

Duct shears

Item	Catalog number	Pieces per package
Wire duct hand cutting tool	QDCUTR	1



QDRVTGUN

Rivet gun

Item	Catalog number	Pieces per package
Rivet gun	QDRVTGUN	1



QDPR4MM

Rivets

Item	Catalog number	Pieces per package
4mm plastic rivet	QDPR4MM	100
6mm plastic rivet	QDPR6MM	



QDPL8-12-S

Plastic label tag

Item	Catalog number	Pieces per package
Suitable for wiring ducts with 8 1/2mm slots only	QDPL8-12-S	100

Tape

Item	Catalog number	Pieces per package
Adhesive tape 6mm wide x 50m long	QDAT6MMX50M	1
Adhesive tape 9mm wide x 50m long	QDAT9MMX50M	

Plastic duct base

Item	Catalog number	Pieces per package
Plastic base	QDPDB	100

Q-Duct

Wire duct cutters

Industrial & production grade

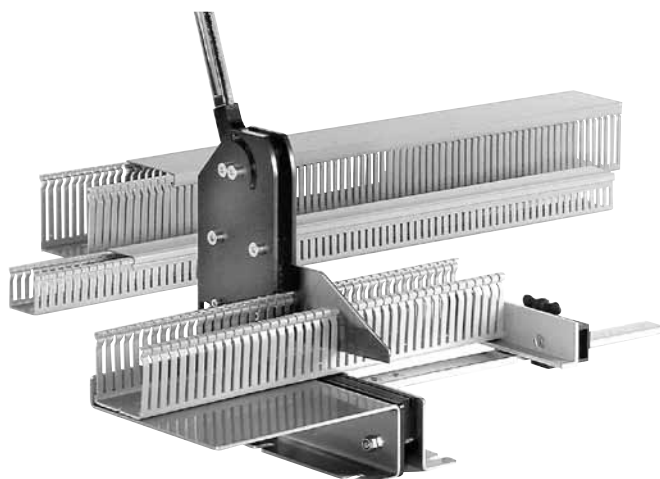

Industrial grade

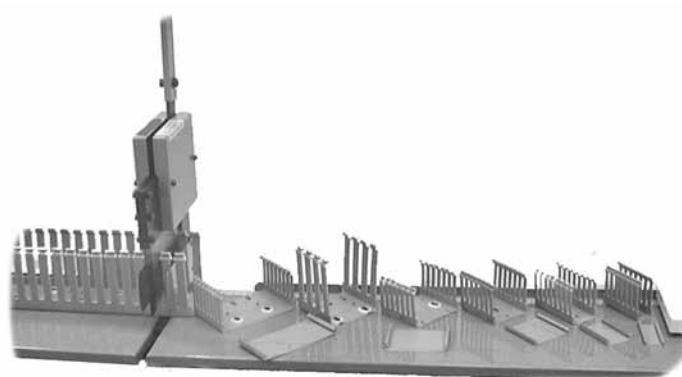

Production grade

Industrial grade

Description	Catalog number
Wire duct cutting machine - Industrial grade	XUS001628
Replacement blade	XUS001629

Technical features

- Length: 1450 mm
- Height: 950 mm
- Depth: 260 mm
- Blade length: 130 mm (maximum wire duct cutting width is 120 mm (5.0 in))
- Blade life: 250,000 cuts
- Blade life is based on usage of traditional PVC wiring duct. Use of halogen-free wiring or any other wiring duct containing abrasive material dramatically reduces the blade life
- Bench mounting material not included.

Production grade

Description	Catalog number
Wire duct cutting machine - Production grade	XUS002518
Replacement blade	XUS002519

Technical features

- Length: 1290 mm
- Height: 785 mm
- Depth: 285 mm
- Blade length: 136 mm (maximum wire duct cutting width is 120 mm (5.0 in))
- Blade life: 400,000 cuts
- Blade life is based on usage of traditional PVC wiring duct. Use of halogen-free wiring or any other wiring duct containing abrasive material dramatically reduces the blade life
- Calibrated scale
- Bench mounting material not included.

Q-Duct

Resistance to chemical agents

Technical data

Resistance to chemical agents

Chemical	Concentration	Temp. °C	Resistance
Acetic acid, hydrous	10%	50	①
Acetic acid	60%	50	①
Acetone	Traces	20	②
Acetone	100%	20	②
Acqua regia	—	20	①
Ammonia concentrate	88%	50	①
Ammonia, dry gas	100%	50	①
Ammonia, liquid	100%	20	③
Aniline, pure	100%	20	②
Arsenic acid, hydrous	concentrated	20	①
Barium hydroxide, hydr.	—	50	①
Beer	commercial	20	①
Benzene	—	20	②
Benzoic acid	—	20	③
Borax, hydrous	thinned	50	①
Boric acid, hydrous	thinned	50	①
Brandy	commercial	20	①
Bromide liquid	—	20	②
Butane gaseous	—	20	①
Butadiene	50%	50	①
Butanol	—	20	①
Butyric acid, hydrous	20%	20	①
Calcium chloride	—	50	①
Camphor oil	—	20	①
Carbon tetrachloride	—	20	③
Chlorine gaseous, dry	100%	20	①
Chlorine gaseous, moist	20%	20	③
Chlorine water	saturated	20	③
Chromic acid, hydrous	—	50	①
Citric acid, hydrous	—	50	①
Copper sulphate, hydrous	thinned	50	①
Diesel oil	—	20	①
Ethyl-alcohol	100% (in water)	20	①
Formaldehyde, hydrous	40%	50	①

Chemical	Concentration	Temp. °C	Resistance
Formic acid	100%	20	①
Freon 12	—	20	①
Gasoline	—	50	①
Glycerine, hydrous	—	50	①
Hydrochloric acid	saturated	50	①
Hydrogen	—	50	①
Linseed oil	—	50	①
Lubricating oils	—	50	①
Mineral oil	—	50	①
Molasses	—	20	④
Oils and fats	commercial	50	①
Oil of turpentine	commercial	20	①
Ozone	—	20	①
Paraffin wax	—	50	①
Photographic developer	commercial	50	①
Photographic emulsions	—	50	①
Potassium permanganate	6%	20	①
Propane, liquid	—	20	①
Salicylic acid	—	50	①
Sea water	—	50	①
Soda, hydrous	saturated	50	①
Sodium chloride	thinned	50	①
Spirits, all types	—	20	①
Sulphur	—	50	①
Sulphuric acid, hydrous	40%	50	①
Tannic acid	—	50	①
Tetrahydrofuran	—	20	②
Toluene	—	20	②
Urea, hydrous	—	50	①
Urine	—	50	①
Vinegar	commercial	50	①
Water	—	50	①
Wines, red & white	commercial	20	①
Zinc sulphate, hydrous	thinned	50	①

14

Technical data

- Gray - RAL 7030
- White - RAL 9016
- Plastic insulating, shock-proof, self-extinguishing material in compliance with UL 94 VO Standard and resistant to abnormal heat and fire up to 960° (glow wire test) in compliance with IEC 695-2-1 Standard. UL File # E125800
- Minimum storage/transport temperature -5°C
- Minimum installation and usage temperature -15°C
- Maximum usage temperature +60°C
- Resistance to acids, oils and greases



Q-Duct

Wire capacity, 18-750 AWG

Wire duct, ties, spiral wrap

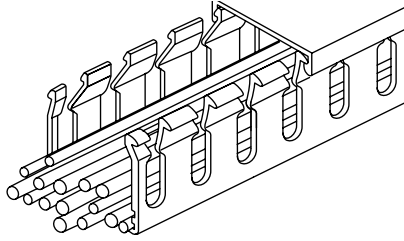

18 - 1 AWG

Gray 4/6 slot Catalog number	Gray 8/12 slot Catalog number	White 4/6 slot Catalog number	White 8/12 slot Catalog number	Size (mm)	Size (inches)	Areas (mm ²)	Maximum number of wires according to AWG & mm ²														
							18 0.82	16 1.3	14 2.1	12 3.3	10 5.3	8 8.4	6 13.3	4 21.2	3 26.7	2 33.6	1 42.4				
QD050X050HG	QD050X050SG	QD050X050HW	QD050X050SW	15x17	1/2x5/8	110	67	42	26	16	10	6	4	2	2	1	1				
QD100X125HG	QD100X125SG	QD100X125HW	QD100X125SW	25x30	1x11/4	490	298	188	116	74	46	29	18	11	9	7	5				
QD150X125HG	QD150X125SG	QD150X125HW	QD150X125SW	40x30	1 1/2x1 1/4	890	542	342	211	134	83	52	33	20	16	13	10				
QD225X125HG	QD225X125SG	QD225X125HW	QD225X125SW	60x30	2 1/4x1 1/4	1430	871	550	340	216	134	85	53	33	26	21	16				
QD100X150HG	QD100X150SG	QD100X150HW	QD100X150SW	25x40	1x1 1/2	710	432	273	169	107	66	42	26	16	13	10	8				
QD150X150HG	QD150X150SG	QD150X150HW	QD150X150SW	40x40	1 1/2x1 1/2	1260	768	484	300	190	118	75	47	29	23	18	14				
QD225X150HG	QD225X150SG	QD225X150HW	QD225X150SW	60x40	2 1/4x1 1/2	2000	1219	769	476	303	188	119	75	47	37	29	23				
QD300X150HG	QD300X150SG	QD300X150HW	QD300X150SW	80x40	3x1 1/2	2710	1652	1042	645	410	255	161	101	63	50	40	31				
QD400X150HG	QD400X150SG	QD400X150HW	QD400X150SW	100x40	4x1 1/2	3460	2109	1330	823	524	326	205	130	81	64	51	40				
QD475X150HG	QD475X150SG	QD475X150HW	QD475X150SW	120x40	4 3/4x1 1/2	4200	2560	1615	1000	636	396	250	157	99	78	62	49				
QD100X225HG	QD100X225SG	QD100X225HW	QD100X225SW	25x60	1 x 2 1/4	1120	682	430	266	169	105	66	42	26	20	16	13				
QD150X225HG	QD150X225SG	QD150X225HW	QD150X225SW	40x60	1 1/2x2 1/4	1970	1201	757	469	298	185	117	74	46	36	29	23				
QD225X225HG	QD225X225SG	QD225X225HW	QD225X225SW	60x60	2 1/4x2 1/4	3060	1865	1176	728	463	288	182	115	72	57	45	36				
QD300X225HG	QD300X225SG	QD300X225HW	QD300X225SW	80x60	3x2 1/4	4190	2554	1611	997	634	395	249	157	98	78	62	49				
QD400X225HG	QD400X225SG	QD400X225HW	QD400X225SW	100x60	4x2 1/4	5320	3243	2046	1266	806	501	316	200	125	99	79	62				
QD475X225HG	QD475X225SG	QD475X225HW	QD475X225SW	120x60	4 3/4x2 1/4	6330	3859	2434	1507	959	597	376	237	149	118	94	74				
QD100X300HG	QD100X300SG	QD100X300HW	QD100X300SW	25x80	1x3	1540	939	592	366	233	145	91	57	36	28	22	18				
QD150X300HG	QD150X300SG	QD150X300HW	QD150X300SW	40x80	1 1/2x3	2670	1628	1026	635	404	251	158	100	62	50	39	31				
QD225X300HG	QD225X300SG	QD225X300HW	QD225X300SW	60x80	2 1/4x3	4140	2524	1592	985	627	390	246	155	97	77	61	48				
QD300X300HG	QD300X300SG	QD300X300HW	QD300X300SW	80x80	3x3	5650	3445	2173	1345	856	533	336	212	133	105	84	66				
QD400X300HG	QD400X300SG	QD400X300HW	QD400X300SW	100x80	4x3	7170	4371	2757	1707	1086	676	426	269	169	134	106	84				
QD475X300HG	QD475X300SG	QD475X300HW	QD475X300SW	120x80	4 3/4x3	8570	5225	3296	2040	1298	808	510	322	202	160	127	101				
QD100X400HG	QD100X400SG	QD100X400HW	QD100X400SW	25x100	1x4	1970	1201	757	469	298	185	117	74	46	36	29	23				
QD150X400HG	QD150X400SG	QD150X400HW	QD150X400SW	40x100	1 1/2x4	3410	2079	1311	811	516	321	202	128	80	63	50	40				
QD225X400HG	QD225X400SG	QD225X400HW	QD225X400SW	60x100	2 1/4x4	5300	3231	2038	1261	803	500	315	199	125	99	78	62				
QD300X400HG	QD300X400SG	QD300X400HW	QD300X400SW	80x100	3x4	7190	4384	2765	1711	1089	678	427	270	169	134	106	84				
QD400X400HG	QD400X400SG	QD400X400HW	QD400X400SW	100x100	4x4	9110	5554	3503	2169	1380	859	542	342	214	170	135	107				
QD600X400HG	QD600X400SG	QD600X400HW	QD600X400SW	150x100	6x4	13,740	8378	5284	3271	2081	1296	817	516	324	257	204	162				

1/0 - 750 AWG

Gray 4/6 slot Catalog number	Gray 8/12 slot Catalog number	White 4/6 slot Catalog number	White 8/12 slot Catalog number	Size (mm)	Size (inches)	Areas (mm ²)	Maximum number of wires according to AWG & mm ²													
							1/0 53.5	2/0 67.4	3/0 85	4/0 107.2	250 127	300 152	350 177	400 203	500 253	600 304	750 380			
QD050X050HG	QD050X050SG	QD050X050HW	QD050X050SW	15x17	1/2x5/8	110	1	0	0	0	0	0	0	0	0	0	0	0	0	0
QD100X125HG	QD100X125SG	QD100X125HW	QD100X125SW	25x30	1x1 1/4	490	4	3	2	2	1	1	1	1	1	1	0	0	0	0
QD150X125HG	QD150X125SG	QD150X125HW	QD150X125SW	40x30	1 1/2x1 1/4	890	8	6	5	4	3	2	2	2	2	1	1	1	1	1
QD225X125HG	QD225X125SG	QD225X125HW	QD225X125SW	60x30	2 1/4x1 1/4	1430	13	10	8	6	5	4	4	3	2	2	2	2	2	2
QD100X150HG	QD100X150SG	QD100X150HW	QD100X150SW	25x40	1x1 1/2	710	6	5	4	3	2	2	2	1	1	1	1	1	0	0
QD150X150HG	QD150X150SG	QD150X150HW	QD150X150SW	40x40	1 1/2x1 1/2	1260	11	9	7	5	4	4	3	3	3	2	2	2	2	2
QD225X150HG	QD225X150SG	QD225X150HW	QD225X150SW	60x40	2 1/4x1 1/2	2000	18	14	11	9	7	6	5	4	3	3	3	2	2	2
QD300X150HG	QD300X150SG	QD300X150HW	QD300X150SW	80x40	3x1 1/2	2710	25	20	15	12	10	8	7	6	5	4	3	3	3	3
QD400X150HG	QD400X150SG	QD400X150HW	QD400X150SW	100x40	4x1 1/2	3460	32	25	20	16	13	11	9	8	6	5	4	3	3	3
QD475X150HG	QD475X150SG	QD475X150HW	QD475X150SW	120x40	4 3/4x1 1/2	4200	39	31	24	19	16	13	11	10	8	6	5	4	3	3
QD100X225HG	QD100X225SG	QD100X225HW	QD100X225SW	25x60	1x2 1/4	1120	10	8	6	5	4	3	3	2	2	2	1	1	1	1
QD150X225HG	QD150X225SG	QD150X225HW	QD150X225SW	40x60	1 1/2x2 1/4	1970	18	14	11	9	7	6	5	4	3	3	3	2	2	2
QD225X225HG	QD225X225SG	QD225X225HW	QD225X225SW	60x60	2 1/4x2 1/4	3060	28	22	18	14	12	10	8	7	6	5	4	3	3	3
QD300X225HG	QD300X225SG	QD300X225HW	QD300X225SW	80x60	3x2 1/4	4190	39	31	24	19	16	13	11	10	8	6	5	4	3	3
QD400X225HG	QD400X225SG	QD400X225HW	QD400X225SW	100x60	4x2 1/4	5320	49	39	31	24	20	17	15	13	10	8	7	6	5	4
QD475X225HG	QD475X225SG	QD475X225HW	QD475X225SW	120x60	4 3/4x2 1/4	6330	59	46	37	29	24	20	17	15	12	10	8	7	6	5
QD100X300HG	QD100X300SG	QD100X300HW	QD100X300SW	25x80	1x3	1540	14	11	9	7	6	5	4	3	3	2	2	2	2	2
QD150X300HG	QD150X300SG	QD150X300HW	QD150X300SW	40x80	1 1/2x3	2670	24	19	15	12	10	8	7	6	5	4	3	3	3	3
QD225X300HG	QD225X300SG	QD225X300HW	QD225X300SW	60x80	2 1/4x3	4140	38	30	24	19	16	13	11	10	8	6	5	4	3	3
QD300X300HG	QD300X300SG	QD300X300HW	QD300X300SW	80x80	3x3	5650	52	41	33	26	22	18	15	13	11	9	7	6	5	4
QD400X300HG	QD400X300SG	QD400X300HW	QD400X300SW	100x80	4x3	7170	67	53	42	33	28	23	20	17	14	11	9	7	6	5
QD475X300HG	QD475X300SG	QD475X300HW	QD475X300SW	120x80	4 3/4x3	8570	80	63	50	39	33	28	24	21	16	14	11	9	7	6
QD100X400HG	QD100X400SG	QD100X400HW	QD100X400SW	25x100	1x4	1970	18	14	11	9	7	6	5	4	3	3	2	2	2	2
QD150X400HG	QD150X400SG	QD150X400HW	QD150X400SW	40x100	1 1/2x4	3410	31	25	20	15	13	11	9	8	6	5	4	3	3	3
QD225X400HG	QD225X400SG	QD225X400HW	QD225X400SW	60x100	2 1/4x4	5300	49	39	31	24	20	17	14	13	10	8	6	5	4	3
QD300X400HG	QD300X400SG	QD300X400HW	QD300X400SW	80x100	3x4	7190	67	53	42	33	28	23	20	17	14	11	9	7	6	5
QD400X400HG	QD400X400SG	QD400X400HW	QD400X400SW	100x100	4x4	9110	85	67	53	42	35	29	25	22	18	14	11	9	7	6
QD600X400HG	QD600X400SG	QD600X400HW	QD600X400SW	150x100	6x4	13,740	128	101	80	64	54	45	38	33	27	22	18	14	11	9

Wire duct, ties,
spiral wrap

Q-Duct

Wire capacity, 800-1000 AWG

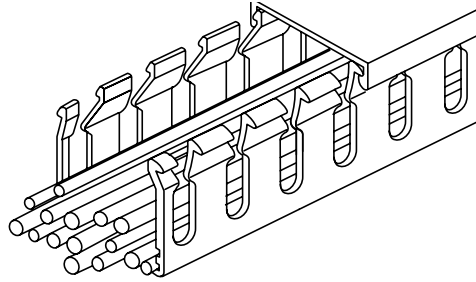

800 - 1000 AWG

Gray 4/6 slot Catalog number	Gray 8/12 slot Catalog number	White 4/6 slot Catalog number	White 8/12 slot Catalog number	Nominal size (mm)	Nominal size (inches)	Usable areas (mm ²)	Maximum number of wires according to AWG and cable section (mm ²)	
							800 405	1000 508
QD050X050HG	QD050X050SG	QD050X050HW	QD050X050SW	15x17	1/2x5/8	110	0	0
QD100X125HG	QD100X125SG	QD100X125HW	QD100X125SW	25x30	1x1 1/4	490	0	0
QD150X125HG	QD150X125SG	QD150X125HW	QD150X125SW	40x30	1 1/2x1 1/4	890	1	0
QD225X125HG	QD225X125SG	QD225X125HW	QD225X125SW	60x30	2 1/4x1 1/4	1430	1	1
QD100X150HG	QD100X150SG	QD100X150HW	QD100X150SW	25x40	1x1 1/2	710	0	0
QD150X150HG	QD150X150SG	QD150X150HW	QD150X150SW	40x40	1 1/2x1 1/2	1260	1	1
QD225X150HG	QD225X150SG	QD225X150HW	QD225X150SW	60x40	2 1/4x1 1/2	2000	2	1
QD300X150HG	QD300X150SG	QD300X150HW	QD300X150SW	80x40	3x1 1/2	2710	3	2
QD400X150HG	QD400X150SG	QD400X150HW	QD400X150SW	100x40	4x1 1/2	3460	4	3
QD475X150HG	QD475X150SG	QD475X150HW	QD475X150SW	120x40	4 3/4x1 1/2	4200	5	4
QD100X225HG	QD100X225SG	QD100X225HW	QD100X225SW	25x60	1 x 2 1/4	1120	1	—
QD150X225HG	QD150X225SG	QD150X225HW	QD150X225SW	40x60	1 1/2x2 1/4	1970	2	1
QD225X225HG	QD225X225SG	QD225X225HW	QD225X225SW	60x60	2 1/4x2 1/4	3060	3	3
QD300X225HG	QD300X225SG	QD300X225HW	QD300X225SW	80x60	3x2 1/4	4190	5	4
QD400X225HG	QD400X225SG	QD400X225HW	QD400X225SW	100x60	4x2 1/4	5320	6	5
QD475X225HG	QD475X225SG	QD475X225HW	QD475X225SW	120x60	4 3/4x2 1/4	6330	7	6
QD100X300HG	QD100X300SG	QD100X300HW	QD100X300SW	25x80	1x3	1540	1	—
QD150X300HG	QD150X300SG	QD150X300HW	QD150X300SW	40x80	1 1/2x3	2670	3	2
QD225X300HG	QD225X300SG	QD225X300HW	QD225X300SW	60x80	2 1/4x3	4140	5	4
QD300X300HG	QD300X300SG	QD300X300HW	QD300X300SW	80x80	3x3	5650	6	5
QD400X300HG	QD400X300SG	QD400X300HW	QD400X300SW	100x80	4x3	7170	8	7
QD475X300HG	QD475X300SG	QD475X300HW	QD475X300SW	120x80	4 3/4x3	8570	10	8
QD100X400HG	QD100X400SG	QD100X400HW	QD100X400SW	25x100	1x4	1970	2	—
QD150X400HG	QD150X400SG	QD150X400HW	QD150X400SW	40x100	1 1/2x4	3410	4	3
QD225X400HG	QD225X400SG	QD225X400HW	QD225X400SW	60x100	2 1/4x4	5300	6	5
QD300X400HG	QD300X400SG	QD300X400HW	QD300X400SW	80x100	3x4	7190	8	7
QD400X400HG	QD400X400SG	QD400X400HW	QD400X400SW	100x100	4x4	9110	11	8
QD600X400HG	QD600X400SG	QD600X400HW	QD600X400SW	150x100	6x4	13,740	16	13

14

Q-Duct

Approximate dimensions

Thermoplastic wiring ducts with 4/6mm slots

CEI 23-22 Standard applies to plastic wiring ducts and their accessories to be used in the mechanical protection and support of cables in switchboards, in application with a maximum rated voltage of 1000 V in alternate current and 1500 V in direct current. Thermoplastic wiring ducts have obtained the IMQ certification.

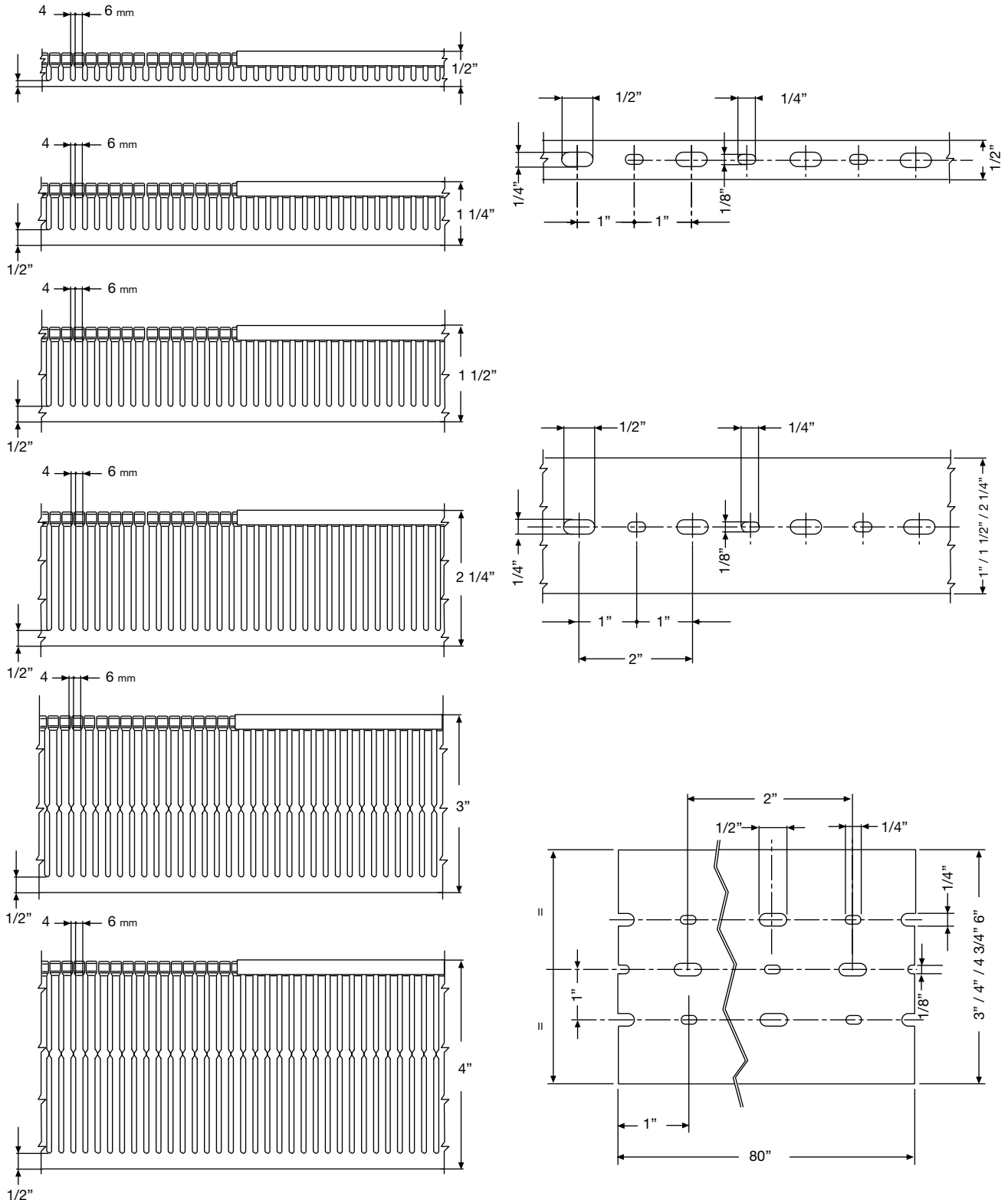

Q-Duct

Approximate dimensions

Thermoplastic wiring ducts with 8/12mm slots

CEI 23-22 Standard applies to plastic wiring ducts and their accessories to be used in the mechanical protection and support of cables in switchboards, in application with a maximum rated voltage of 1000 V in alternate current and 1500 V in direct current. Thermoplastic wiring ducts have obtained the IMQ certification.

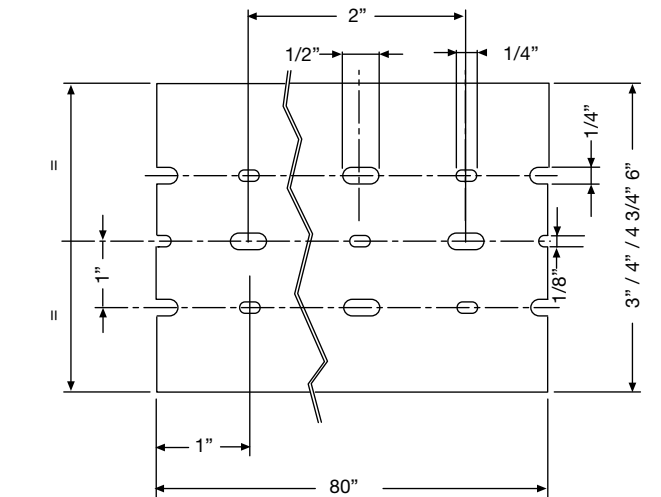
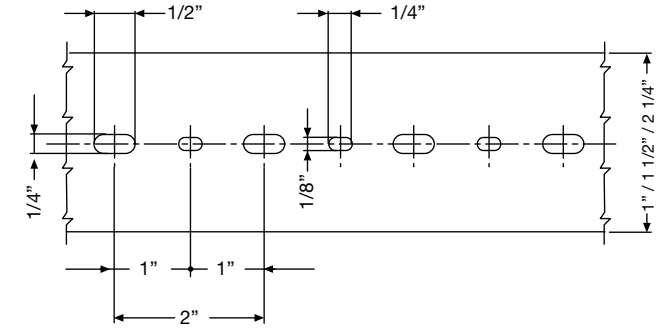
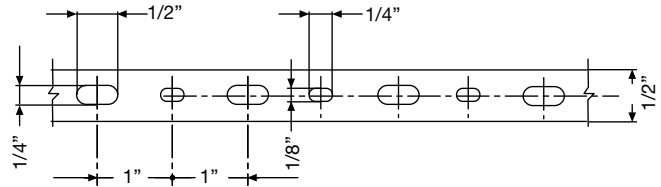
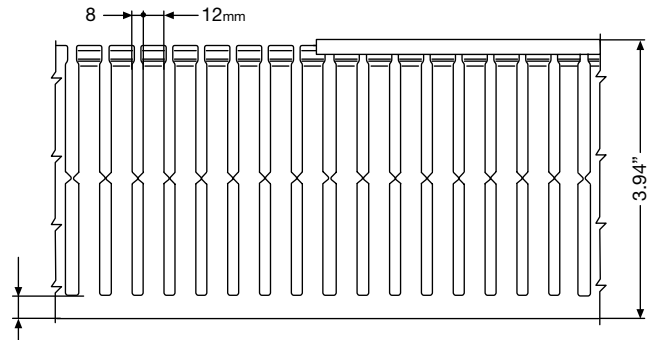
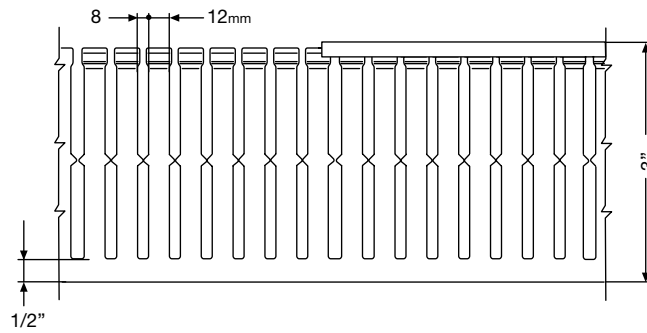
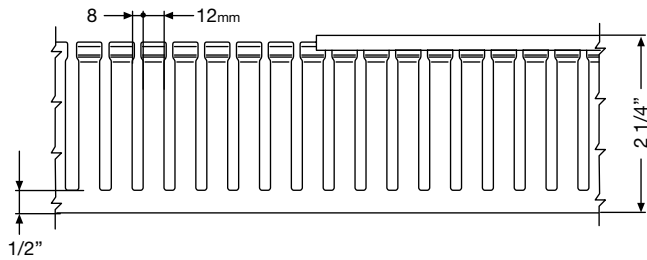
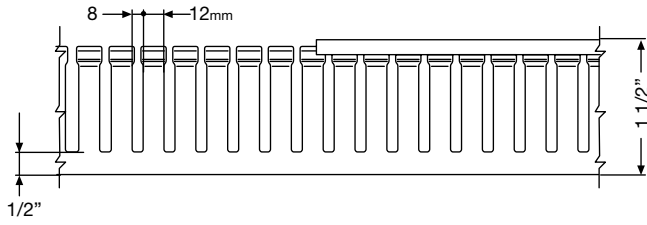
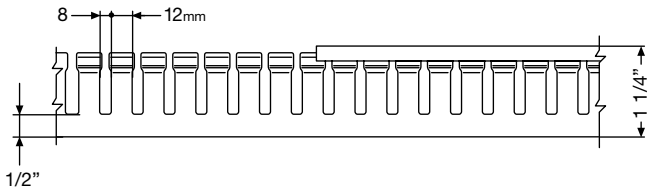
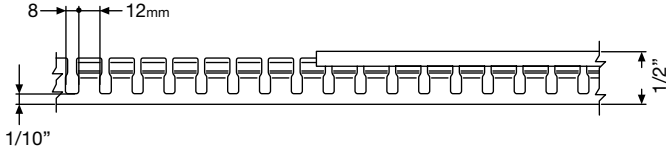

14

Q-Duct

Approximate dimensions
Thermoplastic wiring ducts

Wire duct, ties,
spiral wrap

Plastic rivets and wiring
duct bases

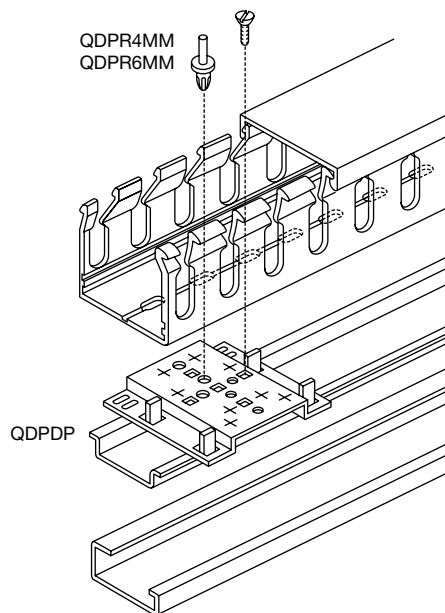

Plastic cable retainers

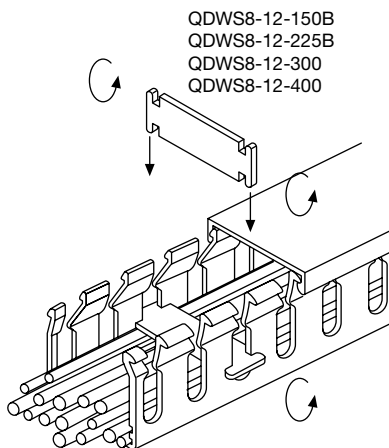

Plastic label tag

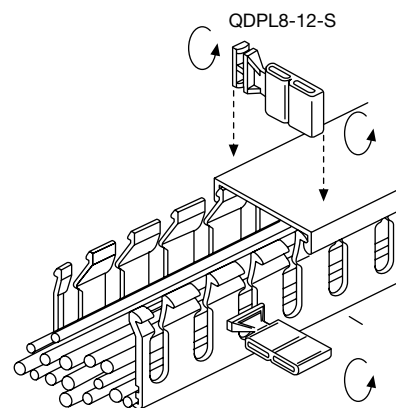

Wire duct, ties,
spiral wrap

Q-Duct

Catalog number cross-reference

Standard density: 8 - 12mm slot

Size (W x H)	ABB Catalog number		Length/Piece		Pieces/ Package (Minimum order Quantity)	Feet Per Package	Meters Per Package	Panduit catalog number (cover not included)		Iboco catalog number (cover included)	
	Gray	White	Feet	Meters				Gray	White	Gray	White
1/2" x 1/2"	QD050X050SG	QD050X050SW	6.6	2	23	152	46	G.5X.5LG6	G.5X.5WH6	T1-0506G	T1-0506W
1" x 1 1/4"	QD100X125SG	QD100X125SW	6.6	2	29	191	58	G1X1LG6	G1X1WH6	T1-1010G	T1-1010W
1 1/2" x 1 1/4"	QD150X125SG	QD150X125SW	6.6	2	20	132	40	G1.5X1LG6	G1.5X1WH6	-	-
2 1/4" x 1 1/4"	QD225X125SG	QD225X125SW	6.6	2	26	172	52	G2X1LG6	G2X1WH6	-	-
1" x 1 1/2"	QD100X150SG	QD100X150SW	6.6	2	24	158	48	G1X1.5LG6	G1X1.5WH6	T1-1015	T1-1015W
1 1/2" x 1 1/2"	QD150X150SG	QD150X150SW	6.6	2	15	99	30	G2X1.5LG6	G2X1.5WH6	T1-1515G	T1-1515W
2 1/4" x 1 1/2"	QD225X150SG	QD225X150SW	6.6	2	20	132	40	G2X1.5LG6	G2X1.5WH6	T1-2215G	T1-2215W
3" x 1 1/2"	QD300X150SG	QD300X150SW	6.6	2	16	106	32	-	-	T1-3015G	T1-3015W
4" x 1 1/2"	QD400X150SG	QD400X150SW	6.6	2	12	79	24	G4X1.5LG6	G4X1.5WH6	T1-4015G	T1-4015W
4 3/4" x 1 1/2"	QD475X150SG	QD475X150SW	6.6	2	10	66	20	-	-	-	-
1" x 2 1/4"	QD100X225SG	QD100X225SW	6.6	2	17	112	34	G1X2LG6	G1X2WH6	T1-1022G	T1-1022W
1 1/2" x 2 1/4"	QD150X225SG	QD150X225SW	6.6	2	11	73	22	G1.5X2LG6	G1.5X2WH6	T1-1522G	T1-1522W
2 1/4" x 2 1/4"	QD225X225SG	QD225X225SW	6.6	2	16	106	32	G2X2LG6	G2X2WH6	T1-2222G	T1-2222W
3" x 2 1/4"	QD300X225SG	QD300X225SW	6.6	2	12	79	24	G3X2LG6	G3X2WH6	T1-3022G	T1-3022W
4" x 2 1/4"	QD400X225SG	QD400X225SW	6.6	2	10	66	20	G4X2LG6	G4X2WH6	T1-4022G	T1-4022W
4 3/4" x 2 1/4"	QD475X225SG	QD475X225SW	6.6	2	7	46	14	-	-	-	-
1" x 3"	QD100X300SG	QD100X300SW	6.6	2	14	92	28	G1X3LG6	G1X3WH6	T1-1030G	T1-1030W
1 1/2" x 3"	QD150X300SG	QD150X300SW	6.6	2	18	119	36	G1.5X3LG6	G1.5X3WH6	T1-1530G	T1-1530W
2 1/4" x 3"	QD225X300SG	QD225X300SW	6.6	2	12	79	24	G2X3LG6	G2X3WH6	T1-2230G	T1-2230W
3" x 3"	QD300X300SG	QD300X300SW	6.6	2	8	53	16	G3X3LG6	G3X3WH6	T1-3030G	T1-3030W
4" x 3"	QD400X300SG	QD400X300SW	6.6	2	8	53	16	G4X3LG6	G4X3WH6	T1-4030G	T1-4030W
4 3/4" x 3"	QD475X300SG	QD475X300SW	6.6	2	6	40	12	-	-	-	-
1" x 4"	QD100X400SG	QD100X400SW	6.6	2	10	66	20	G1X4LG6	G1X4WH6	T1-1040G	T1-1040W
1 1/2" x 4"	QD150X400SG	QD150X400SW	6.6	2	14	92	28	G1.5X4LG6	G1.5X4WH6	T1-1540G	T1-1540W
2 1/4" x 4"	QD225X400SG	QD225X400SW	6.6	2	10	66	20	G2X4LG6	G2X4WH6	T1-2240G	T1-2240W
3" x 4"	QD300X400SG	QD300X400SW	6.6	2	7	46	14	G3X4LG6	G3X4WH6	T1-3040G	T1-3040W
4" x 4"	QD400X400SG	QD400X400SW	6.6	2	4	26	8	G4X4LG6	G4X4WH6	T1-4040G	T1-4040W
6" x 4"	QD600X400SG	QD600X400SW	6.6	2	4	26	8	G6X4LG6	G6X4WH6	T1-6040G	T1-6040W

Q-Duct

Catalog number cross-reference

Wire duct, ties,
spiral wrap

High density: 4-6mm slot

Size (W x H)	ABB Catalog number		Length/Piece		Pieces/ Package (Minimum order Quantity)	Feet Per Package	Meters Per Pack- age	Panduit catalog number (cover not included)		Iboco catalog number (cover included)	
	Gray	White	Feet	Meters				Gray	White	Gray	White
1/2" x 1/2"	QD050X050HG	QD050X050HW	6.6	2	23	152	46	-	-	-	-
1" x 1 1/4"	QD100X125HG	QD100X125HW	6.6	2	29	191	58	F1X1LG1	F1X1WH1	-	-
1 1/2" x 1 1/4"	QD150X125HG	QD150X125HW	6.6	2	20	132	40	F1.5X1LG6	F1.5X1WH6	-	-
2 1/4" x 1 1/4"	QD225X125HG	QD225X125HW	6.6	2	26	172	52	F2X1LG6	F2X1WH6	-	-
1" x 1 1/2"	QD100X150HG	QD100X150HW	6.6	2	24	158	48	F1X1.5LG6	F1X1.5WH6	T1E-1015G	T1E-1015W
1 1/2" x 1 1/2"	QD150X150HG	QD150X150HW	6.6	2	15	99	30	F1.5X1.5LG6	F1.5X1.5WH6	T1E-1515G	T1E-1515W
2 1/4" x 1 1/2"	QD225X150HG	QD225X150HW	6.6	2	20	132	40	F2X1.5LG6	F2X1.5WH6	T1E-2215G	T1E-2215W
3" x 1 1/2"	QD300X150HG	QD300X150HW	6.6	2	16	106	32	-	-	T1E-3015G	T1E-3015W
4" x 1 1/2"	QD400X150HG	QD400X150HW	6.6	2	12	79	24	-	-	T1E-4015G	T1E-4015W
4 3/4" x 1 1/2"	QD475X150HG	QD475X150HW	6.6	2	10	66	20	-	-	-	-
1" x 2 1/4"	QD100X225HG	QD100X200HW	6.6	2	17	112	34	F1X2LG6	F1X2WH6	T1E-1022G	T1E-1022W
1 1/2" x 2 1/4"	QD150X225HG	QD150X225HW	6.6	2	11	73	22	F1.5X2LG6	F1.5X2WH6	T1E-1522G	T1E-1522W
2 1/4" x 2 1/4"	QD225X225HG	QD225X225HW	6.6	2	16	106	32	F2X2LG6	F2X2WH6	T1E-2222G	T1E-2222W
3" x 2 1/4"	QD300X225HG	QD300X225HW	6.6	2	12	79	24	F3X2LG6	F3X2WH6	T1E-3022G	T1E-3022W
4" x 2 1/4"	QD400X225HG	QD400X225HW	6.6	2	10	66	20	F4X2LG6	F4X2WH6	T1E-4022G	T1E-4022W
4 3/4" x 2 1/4"	QD475X225HG	QD475X225HW	6.6	2	7	46	14	-	-	-	-
1" x 3"	QD100X300HG	QD100X300HW	6.6	2	14	92	28	F1X3LG6	F1X3WH6	T1E-1030G	T1E-1030W
1 1/2" x 3"	QD150X300HG	QD150X300HW	6.6	2	18	119	36	F1.5X3LG6	F1.5X3WH6	T1E-1530G	T1E-1530W
2 1/4" x 3"	QD225X300HG	QD225X300HW	6.6	2	12	79	24	F2X3LG6	F2X3WH6	T1E-2230G	T1E-2230W
3" x 3"	QD300X300HG	QD300X300HW	6.6	2	8	53	16	F3X3LG6	F3X3WH6	T1E-3030G	T1E-3030W
4" x 3"	QD400X300HG	QD400X300HW	6.6	2	8	53	16	F4X3LG6	F4X3WH6	T1E-4030G	T1E-4030W
4 3/4" x 3"	QD475X300HG	QD475X300HW	6.6	2	6	40	12	-	-	-	-
1" x 4"	QD100X400HG	QD100X400HW	6.6	2	10	66	20	F1X4LG6	F1X4WH6	-	-
1 1/2" x 4"	QD150X400HG	QD150X400HW	6.6	2	14	92	28	F1.5X4LG6	F1.5X4WH6	-	-
2 1/4" x 4"	QD225X400HG	QD225X400HW	6.6	2	10	66	20	F2X4LG6	F2X4WH6	-	-
3" x 4"	QD300X400HG	QD300X400HW	6.6	2	7	46	14	F3X4LG6	F3X4WH6	-	-
4" x 4"	QD400X400HG	QD400X400HW	6.6	2	4	26	8	F4X4LG6	F4X4WH6	T1E-4040G	T1E-4040W
6" x 4"	QD600X400HG	QD600X400HW	6.6	2	4	26	8	-	-	-	-

Wire duct sample kits

Wire duct sample kits

Description	Catalog number
Standard Cable Tie - Sample Kit	QT-SAMPL-STDITIES
Large Cable Tie - Sample Kit	QT-SAMPL-LGTIES
Cable Tie Mounting Bases - Sample Kit	QT-SAMPL-MBA
Standard Wire Duct (Gray) - Sample Kit	QD-SAMPL-STDG
Standard Wire Duct (White) - Sample Kit	QD-SAMPL-STDW
High Density Wire Duct (Gray) - Sample Kit	QD-SAMPL-HIDENSG
Square Flexible Wire Duct - Sample Kit	QD-SAMPL-SQR
Round Flexible Wire Duct - Sample Kit	QD-SAMPL-RND
Spiral Wrap - Sample Kit	QD-SAMPL-SPIRAL



Locate QR Code Reader
on smart device APP site

Wire Duct Sample kits are available for order
through your ABB sales representative.

Q-Flex Flexible wiring duct



Q-Flex Flexible wiring duct



Flexible wiring duct (Square - Gray) - 20" length per piece

Dimensions WXH (in)	Dimensions WXH (mm)	Catalog number	Pieces per package
1/2 x 1/2	12.5 x 12.5	QDF050X050G	112
5/8 x 5/8	16 x 16	QDF058X058G	84
3/4 x 3/4	20 x 20	QDF075X075G	112
1 x 1	25 x 25	QDF100X100G	70
1 1/4 x 1 1/4	30 x 30	QDF125X125G	50
1 1/2 x 1 1/2	40 x 40	QDF150X150G	50
2 x 2	50 x 50	QDF200X200G	32

Flexible wiring duct (Round - White) - 19.5" length per piece

Inside diameter (in)	Inside diameter (mm)	Catalog number	Pieces per package
3/8	10	QT-10	700
3/4	20	QT-20	350
1 1/2	30	QT-30	200
1 3/4	40	QT-40	100

Sold in package quantity only. Order quantity must be equal to quantity shown in "pieces per package" column.

Technical data

- RAL 7040 Gray
- Plastic, insulating, shock-proof, self-extinguishing material in compliance with UL 94 V2 Standard and resistant to permanent temperature of 80°C and peaks up to 110°C in compliance with IEC 216 Standards
- Resistant to acids, oils and greases
- Ribs alternate and angle slightly inwards to make it easier to insert and extract cables
- No covers so cables can be constantly monitored
- Possibility of fastening using screws and rivets or bi-adhesive tape which sticks strongly to the steel (pre-mounted)
- Suitable for connecting panels and doors with compass-opening mechanisms and in general for applications where cabling is subject to bending and twisting
- Standard 500mm length

Wire duct, ties,
spiral wrap

Notes

Q-Wrap spiral wrap



Q-Wrap Spiral wrap

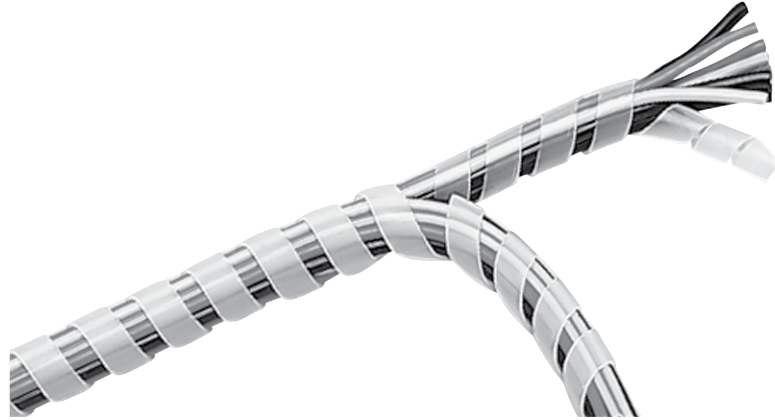

Height in (mm)	Width in (mm)	Diameter Min / Max in (mm)	Translucent Polyethylene Catalog number	Self-extinguishing Polyethylene Catalog number	Length per roll (feet)	Length per roll (meters)
.12 (3)	.2 (5)	.08 (2) / .47 (12)	Q12P164C	Q12SEP164	164	50
.24 (6)	.31 (8)	.2 (5) / 2.20 (56)	Q25P82C	Q24SEP82	82	25
.39 (10)	.43 (11)	.47 (12) / 3.94 (100)	Q39P82C	Q39SEP82	82	25
.47 (12)	.51 (13)	.55 (14) / 5.12 (130)	Q47P82C	Q47SEP82	82	25

Features and benefits

- Options available:
 - Translucent polyethylene
 - Self-extinguishing polyethylene
- For forming of bundles and grouping of wires
- Mechanical protection of cables
- Flexible connections between panel and door

Wire duct, ties,
spiral wrap

Notes

Q-Ties tie wraps

ABB

Q-Ties
Tie wraps



Features

- Easy to install and remove
- Provides protection to the wire bundle
- Available in white and black

Applications

- Fast and economical grouping of wire bundles
- Joining groups of wires and/or tubing
- Flexible connections between door and panel

Q-Ties Cable ties



White



Black

Item	Catalog number	Pieces (per package)
White (6x6) Polyamide		
3.86" (98mm) x 0.10" (2.5mm)	QT400-10W	100
5.31" (135mm) x 0.10" (2.5mm)	QT525-10W	100
6.30" (160mm) x 0.10" (2.6mm)	QT625-10W	100
5.51" (140mm) x 0.14" (3.6mm)	QT550-14W	100
7.87" (200mm) x 0.14" (3.6mm)	QT800-14W	100
11.42" (290mm) x 0.14" (3.6mm)	QT1100-14W	100
7.01" (178mm) x 0.19" (4.8mm)	QT700-14W	100
11.42" (290mm) x 0.19" (4.8mm)	QT1100-17W	100
14.17" (360mm) x 0.19" (4.8mm)	QT1400-17W	100
9.45" (240mm) x 0.31" (7.8mm)	QT800-30W	100
11.81" (300mm) x 0.31" (7.8mm)	QT1100-30W	100
14.37" (365mm) x 0.31" (7.8mm)	QT1400-30W	100
17.72" (450mm) x 0.31" (7.8mm)	QT1700-35W	100
21.26" (540mm) x 0.31" (7.8mm)	QT2150-35W	100
30.71" (780mm) x 0.35" (9.0mm)	QT3075-35W	100
White (6x6 Bulk) Polyamide		
3.86" (98mm) x 0.10" (2.5mm)	QT400-10WB	1000
5.31" (135mm) x 0.10" (2.5mm)	QT525-10WB	1000
6.30" (160mm) x 0.10" (2.6mm)	QT625-10WB	1000
5.51" (140mm) x 0.14" (3.6mm)	QT550-10WB	1000
7.87" (200mm) x 0.14" (3.6mm)	QT800-14WB	1000
Black (6x6) Polyamide		
3.86" (98mm) x 0.10" (2.5mm)	QT400-10B	100
5.31" (135mm) x 0.10" (2.5mm)	QT525-10B	100
5.51" (140mm) x 0.14" (3.6mm)	QT550-10B	100
6.30" (160mm) x 0.10" (2.6mm)	QT625-10B	100
7.87" (200mm) x 0.14" (3.6mm)	QT800-14B	100
11.42" (290mm) x 0.14" (3.6mm)	QT1100-14B	100
7.01" (178mm) x 0.19" (4.8mm)	QT700-17B	100
11.42" (290mm) x 0.19" (4.8mm)	QT1100-17B	100
14.17" (360mm) x 0.19" (4.8mm)	QT1400-17B	100
9.45" (240mm) x 0.31" (7.8mm)	QT800-30B	100
11.81" (300mm) x 0.31" (7.8mm)	QT1100-30B	100
14.37" (365mm) x 0.31" (7.8mm)	QT1400-30B	100
17.72" (450mm) x 0.31" (7.8mm)	QT1700-35B	100
21.26" (540mm) x 0.31" (7.8mm)	QT2150-35B	100
30.71" (780mm) x 0.35" (9.0mm)	QT3075-35B	100
Black (6x6 Bulk) Polyamide		
3.86" (98mm) x 0.10" (2.5mm)	QT400-10BB	1000
5.31" (135mm) x 0.10" (2.5mm)	QT525-10BB	1000
6.30" (160mm) x 0.10" (2.6mm)	QT625-10BB	1000
5.51" (140mm) x 0.14" (3.6mm)	QT550-10BB	1000
7.87" (200mm) x 0.14" (3.6mm)	QT800-14BB	1000
Black (12 Polyamide)		
4.53" (115mm) x 0.24" (6mm)	QT400-24B	100
7.09" (180mm) x 0.24" (6mm)	QT700-24B	100
5.20" (132mm) x 0.35" (9mm)	QT450-35B	100
7.09" (180mm) x 0.35" (9mm)	QT700-35B	100
10.24" (260mm) x 0.35" (9mm)	QT1050-35B	100
14.17" (360mm) x 0.35" (9mm)	QT1400-35B	100

Sold in package quantity only.

Q-Ties Accessories

Cable tie accessories



QTAB-C



QTAB-B



QTCTR



QTSM-B



QTP-INB



QTOCTCTR

Item	Catalog number	Pieces per package ①
Self-adhesive base for cable ties (clear)	QTAB-C	50
Self-adhesive base for cable ties (black)	QTAB-B	50
Screw mounted base for cable ties (clear)	QTSM-C	100
Screw mounted base for cable ties (black)	QTSM-B	100
Cable tie cutter	QTCTR	1
Screw mounted base for cable ties (clear)	QTSMB	25
Push-in base for cable ties	QTP-INB	25
Outer cable tie cutter	QTOCTCTR	1

① Sold in package quantity only.

Q-Ties

Technical data & approximate dimensions

General features

- Self extinguishing class according to UL 94: V2
- Manufactured in 6/6 nylon; Colorless for general uses
- Better stored at mild temperatures, away from heat and excessively dry conditions
- Black cable ties are UV resistant; excellent for outdoor applications

Thermal properties

- Suitable for use at temperatures from -40° to +85°C
- Softening point VICAT VST/B/50-DIN 53460 over 200°C

Electrical characteristics











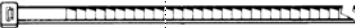

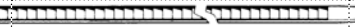





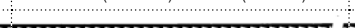
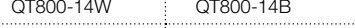
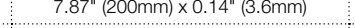

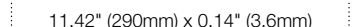
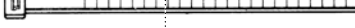
- Dielectric endurance 50,000 V/mm

Chemical characteristics

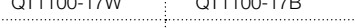
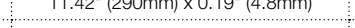
- Good resistance to bases, oil, grease, hydrocarbons, acetone, chlorales
- Limited concentrated acid resistance
- Dissolved by phenol and formic acid

Mechanical characteristics

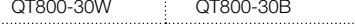
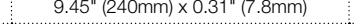
- Bending point DIN 53452 110 M Pa
- Load point DIN 53457 2800 M Pa
- Resilience DIN 53453 6-8 KJ/m²
- Yield point DIN 53456 80 M Pa
- Stretch point DIN 53455 35%
- Hardness DIN 53456 125 N/mm²

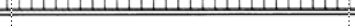
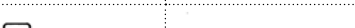
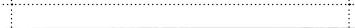
White polyamide catalog number	Black polyamide catalog number	Size L x W In (mm) x In (mm)	Tightening diameter		Tensile strength	
			Minimum In (mm)	Maximum In (mm)	N	Lbs.
 QT400-10W	 QT400-10B	3.86" (98mm) x 0.10" (2.5mm)	0.04" (1mm)	0.83" (21mm)	80	176
 QT525-10W	 QT525-10B	5.31" (135mm) x 0.10" (2.5mm)	0.04" (1mm)	1.26" (32mm)	80	176
 QT625-10W	 QT625-10B	6.30" (160mm) x 0.10" (2.6mm)	0.04" (1mm)	1.57" (40mm)	80	176
 QT550-14W	 QT550-14B	5.51" (140mm) x 0.14" (3.6mm)	0.08" (2mm)	1.38" (35mm)	130	286
 QT800-14W	 QT800-14B	7.87" (200mm) x 0.14" (3.6mm)	0.08" (2mm)	1.97" (50mm)	130	286
 QT1100-14W	 QT1100-14B	11.42" (290mm) x 0.14" (3.6mm)	0.08" (2mm)	3.15" (80mm)	130	286
 QT700-14W	 QT700-14B	7.01" (178mm) x 0.19" (4.8mm)	0.08" (2mm)	1.77" (45mm)	220	484
 QT1100-17W	 QT1100-17B	11.42" (290mm) x 0.19" (4.8mm)	0.14" (3.5mm)	3.11" (79mm)	220	484
 QT1400-17W	 QT1400-17B	14.17" (360mm) x 0.19" (4.8mm)	0.14" (3.5mm)	4.06" (103mm)	220	484
 QT800-30W	 QT800-30B	9.45" (240mm) x 0.31" (7.8mm)	0.14" (3.5mm)	2.48" (63mm)	540	1188
 QT1100-30W	 QT1100-30B	11.81" (300mm) x 0.31" (7.8mm)	0.16" (4mm)	3.15" (80mm)	540	1188
 QT1400-30W	 QT1400-30B	14.37" (365mm) x 0.31" (7.8mm)	0.31" (8mm)	3.94" (100mm)	540	1188
 QT1700-35W	 QT1700-35B	17.72" (450mm) x 0.31" (7.8mm)	1.38" (35mm)	5.12" (130mm)	540	1188
 QT2150-35W	 QT2150-35B	21.26" (540mm) x 0.31" (7.8mm)	1.38" (35mm)	6.22" (158mm)	540	1188
 QT3075-35W	 QT3075-35B	30.71" (780mm) x 0.35" (9.0mm)	1.26" (32mm)	9.17" (233mm)	700	1540

14

Q-Ties

Technical data

Approximate dimensions

General features

- Self extinguishing class according to UL 94: V2
- Manufactured in 12 nylon
- Moisture absorption less than 1%
- Black cable ties are UV resistant; excellent for outdoor applications

Thermal properties

- Suitable for use at temperatures from -45° to +85°C
- Softening point VICAT VST/B/50-DIN 53460 over 160°C

Electrical characteristics



- Dielectric endurance 28,000 V/mm

Chemical characteristics

- Good resistance to bases, oil, grease, hydrocarbons, acetone, chlorales
- Limited resistance to nitric and chromic acid
- Dissolved by phenol and formic acids

Mechanical characteristics

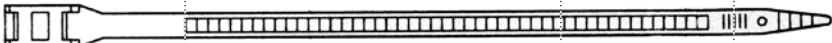
- Bending point DIN 53452 20 M Pa
- Load point DIN 53457 420 M Pa
- Breaking load point DIN 53455 61 M Pa
- Resilience 20°C DIN 53453 KJ/m not broken
- Yield point DIN 53456 24 M Pa
- Stretch point DIN 53455 37%
- Hardness G2 Shore D

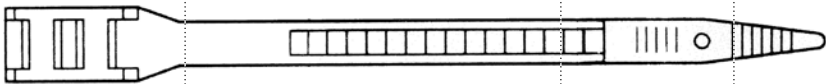
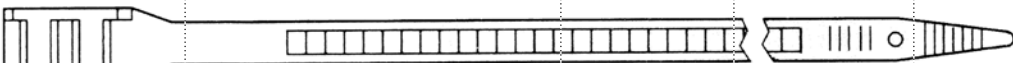
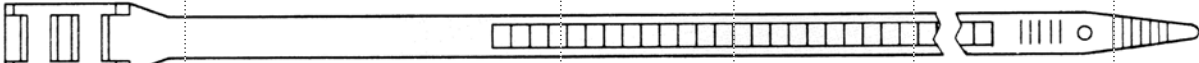
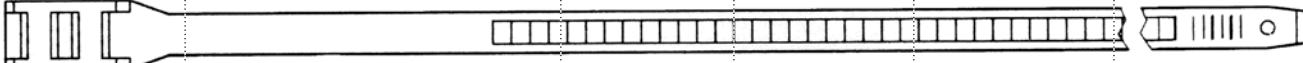
Black polyamide catalog number	Size L x W In (mm) x In (mm)	Tightening diameter		Tensile strength	
		Minimum In (mm)	Maximum In (mm)	N	Lbs.
 QT400-24B	4.53" (115mm) x 0.24" (6mm)	0.20" (5mm)	0.98" (25mm)	280	616
 QT700-24B	7.09" (180mm) x 0.24" (6mm)	0.35" (9mm)	1.77" (45mm)	280	616
 QT450-35B	5.20" (132mm) x 0.35" (9mm)	0.31" (8mm)	1.06" (26mm)	390	858
 QT700-35B	7.09" (180mm) x 0.35" (9mm)	0.39" (10mm)	1.57" (40mm)	390	858
 QT1050-35B	10.24" (260mm) x 0.35" (9mm)	1.02" (26mm)	2.44" (62mm)	540	1188
 QT1400-35B	14.17" (360mm) x 0.35" (9mm)	1.02" (26mm)	3.66" (93mm)	540	1188

Q-Ties

Approximate dimensions

00.00 Inches
00.00 [Millimeters]

QTAB-C & QTAB-B
Self-adhesive base for cable ties

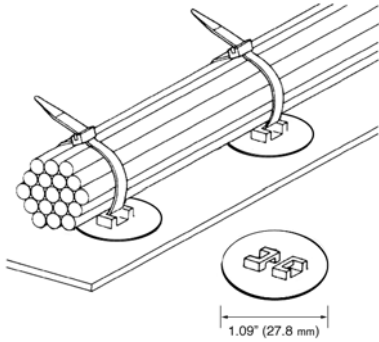

QTSM-C & QTSM-B
Screw-mounted base for cable ties

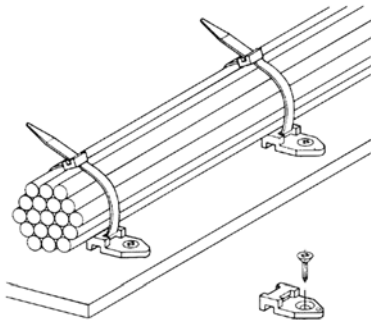

QTSMB
Screw-mounted base for cable ties

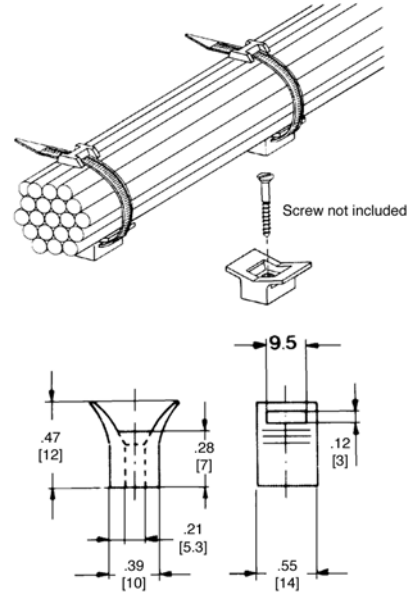

QTP-INB
Push-in base for cable ties

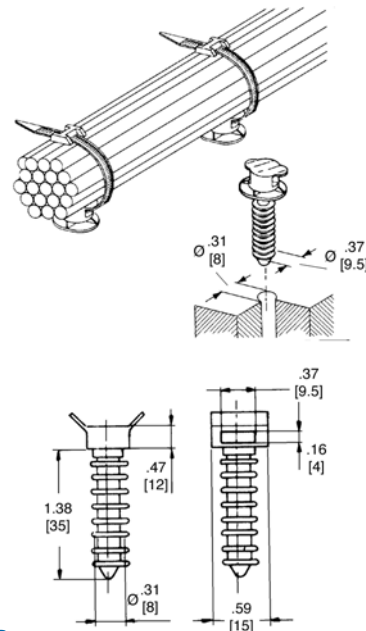

QTCTR
Cable tie cutter

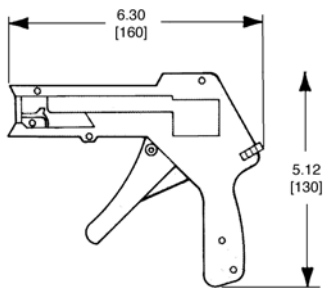

QTOCTCTR
Cable tie cutter

